

Features

- Smallest footprint in chip-scale (CSP): 1.5 x 0.8 mm
- Ultra-low power: <1 μ A
- Supports coin-cell or super-cap battery backup voltages
- Vdd supply range: 1.5V to 3.63V over -40°C to +85°C
- Oscillator output eliminates external load caps
- NanoDrive[™] programmable output swing for lowest power
- Internal filtering eliminates external Vdd bypass cap
- Fixed 32.768 kHz
- <10 ppm initial stability
- <100 ppm stability over -40°C to +85°C
- Pb-free, RoHS and REACH compliant

Applications

- Mobile Phones
- Tablets
- Health and Wellness Monitors
- Fitness Watches
- Sport Video Cams
- Wireless Keypads
- Ultra-Small Notebook PC
- Pulse-per-Second (pps) Timekeeping
- RTC Reference Clock
- Battery Management Timekeeping

扫码关注公众号



INSTANT
SAMPLES



GREEN
SOLUTIONS



LIFETIME
WARRANTY

Electrical Characteristics

Parameter	Symbol	Min.	Typ.	Max.	Unit	Condition
Frequency and Stability						
Fixed Output Frequency	F _{out}		32.768		kHz	
Frequency Stability						
Frequency Stability ^[2]	F _{stab}			10	ppm	T _A = 25°C, post reflow, includes underfill, Vdd: 1.5V – 3.63V. Tested with Agilent 53132A freq. counter, gate time \geq 100ms.
				75		T _A = -10°C to +70°C, Vdd: 1.5V – 3.63V. Stability includes initial, power supply, and temperature stability components.
				100		T _A = -40°C to +85°C, Vdd: 1.5V – 3.63V. Stability includes initial, power supply, and temperature stability components.
				250		T _A = -10°C to +70°C, Vdd: 1.2V – 1.5V. Stability includes initial, power supply, and temperature stability components.
25°C Aging		-3		3	ppm	1st Year
Supply Voltage and Current Consumption						
Operating Supply Voltage	Vdd	1.2		3.63	V	T _A = -10°C to +70°C
		1.5		3.63	V	T _A = -40°C to +85°C
Core Operating Current ^[3, 4]	I _{dd}		0.90		μ A	T _A = 25°C, Vdd: 1.5V – 2.5V. No load
				1.3		T _A = -10°C to +70°C, Vdd max: 3.63V. No load
				1.4		T _A = -40°C to +85°C, Vdd max: 3.63V. No load
Output Stage Operating Current ^[3]	I _{dd_out}		0.065	0.125	μ A/Vpp	T _A = -40°C to +85°C, Vdd: 1.5V – 3.63V. No load
Power-Supply Ramp	t _{Vdd_Ramp}			100	ms	Vdd Ramp-up 0 to 90%, T _A = -40°C to +85°C
T _{START-UP} at Power-up	T _{start}		150	300	ms	T _A = -40°C to +85°C
Operating Temperature Range						
Commercial Temperature	T _{use}	-10		70	°C	
Industrial Temperature		-40		85	°C	

Notes:

1. Stability is specified for two operating voltage ranges. Stability progressively degrades with supply voltage below 1.5V. Frequency tests are performed with an Agilent 53132A frequency counter with \geq 100ms gate time.
2. Core operating current does not include output driver operating current or load current.
3. To derive total operating current (no load), add core operating current + (0.065 μ A/V) * (output voltage swing).

SiT1532

Smallest Footprint (1.2mm²), Ultra-Low Power 32.768 kHz Oscillator in CSP



The Smart Timing Choice™

Electrical Characteristics (continued)

Parameter	Symbol	Min.	Typ.	Max.	Unit	Condition
LVC MOS Output Option, T_A = -40°C to +85°C, typical values are at T_A = 25°C						
Output Rise/Fall Time	tr, tf		100	200	ns	10-90%, 15 pF load, Vdd = 1.5V to 3.63V
Output Clock Duty Cycle	DC	48		52	%	
Output Voltage High	VOH	90%			V	Vdd: 1.5V – 3.63V. I _{OH} = -10 μA, 15 pF
Output Voltage Low	VOL			10%	V	Vdd: 1.5V – 3.63V. I _{OL} = 10 μA, 15 pF
NanoDrive™ Programmable, Reduced Swing Output						
Output Rise/Fall Time	tf, tf			200	ns	30-70%, 10 pF Load
Output Clock Duty Cycle	DC	48		52	%	
AC-coupled Programmable Output Swing	V _{sw}		0.20 to 0.80		V	SiT1532 does not internally AC-couple. This output description is intended for a receiver that is AC-coupled. See Table 2 for acceptable NanoDrive swing options. Vdd: 1.5V – 3.63V, 10 pF Load, I _{OH} / I _{OL} = ±0.2 μA.
DC-Biased Programmable Output Voltage High Range	VOH		0.60 to 1.225		V	Vdd: 1.5V – 3.63V. I _{OH} = -0.2 μA, 10 pF Load. See Table 1 for acceptable V _{OH} /V _{OL} setting levels.
DC-Biased Programmable Output Voltage Low Range	VOL		0.35 to 0.80		V	Vdd: 1.5V – 3.63V. I _{OL} = 0.2 μA, 10 pF Load. See Table 1 for acceptable V _{OH} /V _{OL} setting levels.
Programmable Output Voltage Swing Tolerance		-0.055		0.055	V	T _A = -40°C to +85°C, Vdd = 1.5V to 3.63V. See Tables 1 and -2 for acceptable NanoDrive Settings.
Period Jitter	T _{jitt}		35		ns _{RMS}	N = 10,000, T _A = 25°C, Vdd = 1.5V – 3.63V

Pin Configuration

Pin	Symbol	I/O	Functionality
1, 4	GND	Power Supply Ground	Connect to ground. Acceptable to connect pin 1 and 4 together. Both pins must be connected to GND.
2	CLK Out	OUT	Oscillator clock output. The CLK can drive into a Ref CLK input or into an ASIC or chip-set's 32kHz XTAL input. When driving into an ASIC or chip-set oscillator input (X IN and X Out), the CLK Out is typically connected directly to the XTAL IN pin. No need for load capacitors. The output driver is intended to be insensitive to capacitive loading.
3	Vdd	Power Supply	Connect to power supply 1.2V ≤ Vdd ≤ 3.63V. Under normal operating conditions, Vdd does not require external bypass/decoupling capacitor(s). For more information about the internal power-supply filtering, see the <i>Power Supply Noise Immunity</i> section in the detailed description. Contact factory for applications that require a wider operating supply voltage range.

CSP Package (Top View)

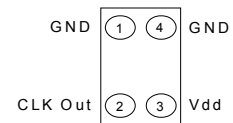

System Block Diagram

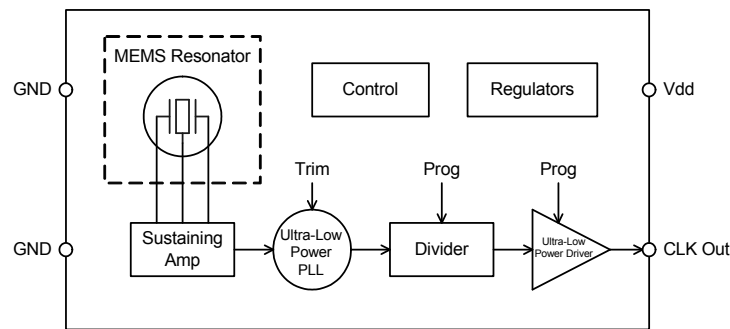

Figure 1.

Absolute Maximum

Attempted operation outside the absolute maximum ratings of may cause permanent damage to the part. Actual performance of the IC is only guaranteed within the operational specifications, not at absolute maximum ratings.

Parameter	Test Condition	Value	Unit
Continuous Power Supply Voltage Range (Vdd)		-0.5 to 3.63	V
Short Duration Maximum Power Supply Voltage (Vdd)	<30 minutes	4.0	V
Continuous Maximum Operating Temperature Range	Vdd = 1.5V - 3.63V	105	°C
Short Duration Maximum Operating Temperature Range	Vdd = 1.5V - 3.63V, ≤30 mins	125	°C
Human Body Model ESD Protection	HBM, JESD22-A114	2000	V
Charge-Device Model (CDM) ESD Protection	JESD220C101	500	V
Machine Model (MM) ESD Protection	T _A = 25°C	200	V
Latch-up Tolerance	JESD78 Compliant		
Mechanical Shock Resistance	Mil 883, Method 2002	10,000	g
Mechanical Vibration Resistance	Mil 883, Method 2007	70	g
1508 CSP Junction Temperature		150	°C

Thermal Consideration

Package	θJA, 4 Layer Board (°C/W)	θJA, 2 Layer Board (°C/W)	θJC, Bottom (°C/W)
1508 CSP	TBD		

Description

The SiT1532 is the world's smallest, lowest power 32 kHz oscillator optimized for mobile and other battery-powered applications. SiTime's silicon MEMS technology enables the smallest footprint and chip-scale packaging. This device reduces the 32 kHz footprint by as much as 85% compared to existing 2.0 x 1.2 mm SMD XTAL packages. Unlike XTALs, the SiT1532 oscillator output enables greater component placement flexibility and eliminates external load capacitors, thus saving additional component count and board space. And unlike standard oscillators, the SiT1532 features NanoDrive™, a factory programmable output that reduces the voltage swing to minimize power.

The 1.2V to 3.63V operating supply voltage range makes it an ideal solution for mobile applications that incorporate a low-voltage, battery-back-up source such as a coin-cell or super-cap.

SiTime's MEMS oscillators consist of MEMS resonators and a programmable analog circuit. Our MEMS resonators are built with SiTime's unique MEMS First™ process. A key manufacturing step is EpiSeal™ during which the MEMS resonator is annealed with temperatures over 1000°C. EpiSeal creates an extremely strong, clean, vacuum chamber that encapsulates the MEMS resonator and ensures the best performance and reliability. During EpiSeal, a poly silicon cap is grown on top of the resonator cavity, which eliminates the need for additional cap wafers or other exotic packaging. As a result, SiTime's MEMS resonator die can be used like any other semiconductor die. One unique result of SiTime's MEMS First and EpiSeal manufacturing processes is the capability to integrate SiTime's MEMS die with a SOC, ASIC, microprocessor or analog die within a package to eliminate external timing components and provide a highly integrated, smaller, cheaper solution to the customer.

Frequency Stability

The SiT1532 is factory calibrated (trimmed) to guarantee frequency stability to be less than 10 ppm at room temperature and less than 100 ppm over the full -40°C to +85°C temperature range. Unlike quartz crystals that have a classic tuning fork parabola temperature curve with a 25°C turnover point, the SiT1532 temperature coefficient is extremely flat across temperature. The device maintains less than 100 ppm frequency stability over the full operating temperature range when the operating voltage is between 1.5 and 3.63V.

When measuring the SiT1532 output frequency with a frequency counter, it is important to make sure the counter's gate time is ≥ 100 ms. The slow frequency of a 32kHz clock will give false readings with faster gate times.

Contact SiTime for applications that require a wider supply voltage range >3.63V or lower frequency options as low as 1Hz.

Power Supply Noise Immunity

In addition to eliminating external output load capacitors common with standard XTALs, The SiT1532 includes special internal power supply filtering and thus, eliminates the need for an external V_{DD} bypass-decoupling capacitor. This feature further simplifies the design and keeps the footprint as small as possible. Internal power supply filtering is designed to reject greater than ± 150 mVpp magnitude and frequency components through 10 MHz.

Output Voltage

The SiT1532 has two output voltage options. One option is a standard LVCMOS output swing. The second option is the NanoDrive reduced swing output. Output swing is customer specific and programmed between 200 mV and 800 mV. For DC-coupled applications, output V_{OH} and V_{OL} are individually factory programmed to the customers' requirement. V_{OH} programming range is between 600 mV and 1.225V in 100 mV increments. Similarly, V_{OL} programming range is between 350 mV and 800 mV. For example; a PMIC or MCU is internally 1.8V logic compatible, and requires a 1.2V V_{IH} and a 0.6V V_{IL}. Simply select SiT1532 NanoDrive factory programming code to be "D14" and the correct output thresholds will match the downstream PMIC or MCU input requirements. Interface logic will vary by manufacturer and we recommend that you review the input voltage requirements for the input interface.

For DC-biased NanoDrive output configuration, the minimum V_{OL} is limited to 350mV and the maximum allowable swing (V_{OH} - V_{OL}) is 750mV. For example, 1.1V V_{OH} and 400mV V_{OL} is acceptable, but 1.2V V_{OH} and 400 mV V_{OL} is not acceptable.

When the output is interfacing to an XTAL input that is internally AC-coupled, the SiT1532 output can be factory programmed to match the input swing requirements. For example, if a PMIC or MCU input is internally AC-coupled and requires an 800mV swing, then simply choose the SiT1532 NanoDrive programming code "AA8" in the part number. It is important to note that the SiT1532 does not include internal AC-coupling capacitors. Please see the *Part Number Ordering* section at the end of the datasheet for more information about the part number ordering scheme.

Power-up

The SiT1532 starts-up to a valid output frequency within 300 ms (150ms typ). To ensure proper start-up, V_{DD} power-supply ramp, from a power-down state to 90% of final V_{DD}, must be less than 100 ms.

SiT1532

Smallest Footprint (1.2mm²), Ultra-Low Power 32.768 kHz Oscillator in CSP

SiT1532 NanoDrive™

Figure 2 shows a typical output waveform of the SiT1532 (into a 10 pF load) when factory programmed for a 0.70V swing and DC bias (V_{OH}/V_{OL}) for 1.8V logic:

Example:

- NanoDrive™ part number coding: D14. Example part number: SiT1532AI-J4-D14-32.768
- $V_{OH} = 1.1V$, $V_{OL} = 0.4V$ ($V_{SW} = 0.70V$)

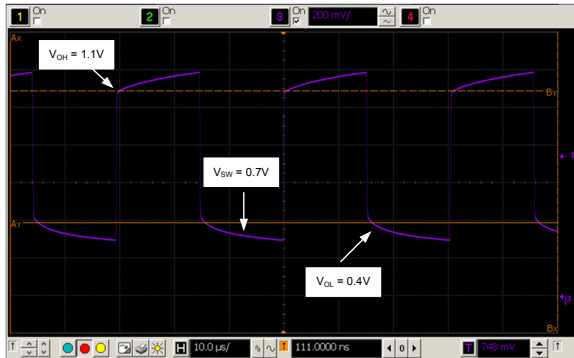

Figure 2. SiT1532AI-J4-D14-32.768 Output Waveform (10 pF load)

Table 1 shows the supported NanoDrive™ V_{OH} , V_{OL} factory programming options.

Table 1. Acceptable V_{OH}/V_{OL} NanoDrive™ Levels

V_{OL}/V_{OH}	1.225	1.100	1.000	0.900	0.800	0.700	0.600
0.800	D28	D18	D08				
0.700	D27	D17	D07	D97			
0.525	D26	D16	D06	D96	D86		
0.500	D25	D15	D05	D95	D85	D75	
0.400		D14	D04	D94	D84	D74	D64
0.350		D13	D03	D93	D83	D73	D63

Table 2 shows the supported AC coupled Swing levels. The “AC-coupled” terminology refers to the programming description for applications where the downstream chipset includes an internal AC-coupling capacitor, and therefore, only the output swing is important and V_{OH}/V_{OL} is not relevant.

For these applications, refer to Table 2 for the acceptable voltage swing options.

Table 2. Acceptable AC-Coupled Swing Levels

Swing	0.800	0.700	0.600	0.500	0.400	0.300	0.250	0.200
Output Code	AA8	AA7	AA6	AA5	AA4	AA3	AA2	AA1

Example:

- NanoDrive part number coding: AA2. Example part number: SiT1532AI-J4-AA2-32.768
- Output voltage swing: 0.250V

The values listed in Tables 1 and -2 are nominal values at 25°C and will exhibit a tolerance of ±55 mV across V_{dd} and -40°C to 85°C operating temperature range.

SiT1532 Full Swing LVC MOS Output

The SiT1532 can be factory programmed to generate full-swing LVC MOS levels. Figure 3 shows the typical waveform ($V_{dd} = 1.8V$) at room temperature into a 15 pF load.

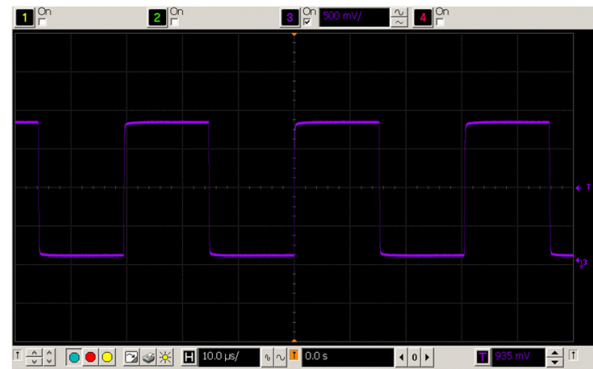

Figure 3. LVC MOS Waveform ($V_{dd} = 1.8V$) into 15 pF Load

Example:

- LVC MOS output part number coding is always **DCC**
- Example part number: SiT1532AI-J4-DCC-32.768

Calculating Load Current

No Load Supply Current

When calculating no-load power for the SiT1532, the core and output driver components need to be added. Since the output voltage swing can be programmed for reduced swing between 250 mV and 800 mV for ultra-low power applications, the output driver current is variable. Therefore, no-load operating supply current is broken into two sections; core and output driver. The equation is as follows:

$$\text{Total Supply Current (no load)} = I_{\text{dd Core}} + (65\text{nA/V})(V_{\text{out_pp}})$$

Example 1: Full-swing LVCMOS

- V_{dd} = 1.8V
- I_{dd Core} = 900nA (typ)
- V_{out_pp} = 1.8V

$$\text{Supply Current} = 900\text{nA} + (65\text{nA/V})(1.8\text{V}) = 1017\text{nA}$$

Example 2: NanoDrive™ Reduced Swing

- V_{dd} = 1.8V
- I_{dd Core} = 900nA (typ)
- V_{out_pp} (Programmable) = V_{OH} - V_{OL} = 1.1V - 0.6V = 500mV

$$\text{Supply Current} = 900\text{nA} + (65\text{nA/V})(0.5\text{V}) = 932\text{nA}$$

Total Supply Current with Load

To calculate the total supply current, including the load, follow the equation listed below. Note the 30% reduction in power with NanoDrive™.

$$\text{Total Current} = I_{\text{dd Core}} + I_{\text{dd Output Driver}} (65\text{nA/V} \cdot V_{\text{out_pp}}) + \text{Load Current} (C \cdot V \cdot F)$$

Example 1: Full-swing LVCMOS

- V_{dd} = 1.8V
- I_{dd Core} = 900nA
- Load Capacitance = 10pF
- I_{dd Output Driver}: (65nA/V)(1.8V) = 117nA
- Load Current: (10pF)(1.8V)(32.768kHz) = 590nA
- Total Current = 900nA + 117nA + 590nA = 1.6μA

Example 2: NanoDrive™ Reduced Swing

- V_{dd} = 1.8V
- I_{dd Core} = 900nA
- Load Capacitance = 10pF
- V_{out_pp} (Programmable): V_{OH} - V_{OL} = 1.1V - 0.6V = 500mV
- I_{dd Output Driver}: (65nA/V)(0.5V) = 33nA
- Load Current: (10pF)(0.5V)(32.768kHz) = 164nA
- Total Current = 900nA + 33nA + 164nA = 1.1μA

SiT1532

Smallest Footprint (1.2mm²), Ultra-Low Power 32.768 kHz
Oscillator in CSP



The Smart Timing Choice™

Typical Operating Curves

(T_A = 25°C, V_{DD} = 1.8V, unless otherwise stated)

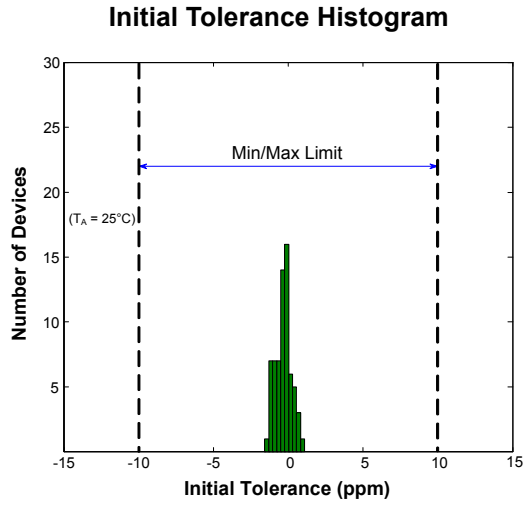

NanoDrive™ Output Waveform

(V_{OH} = 1.1V, V_{OL} = 0.4V; SiT1532AI-J4-D14-32.768)

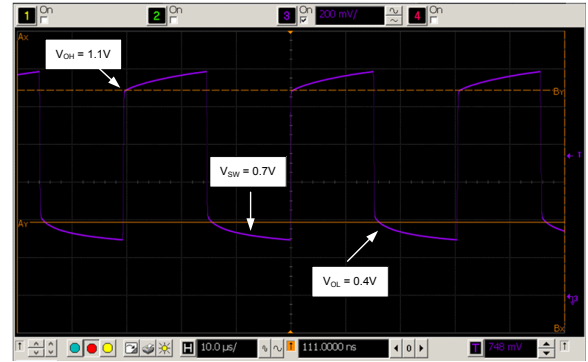

LVC MOS Output Waveform

(SiT1532AI-J4-DCC-32.768)

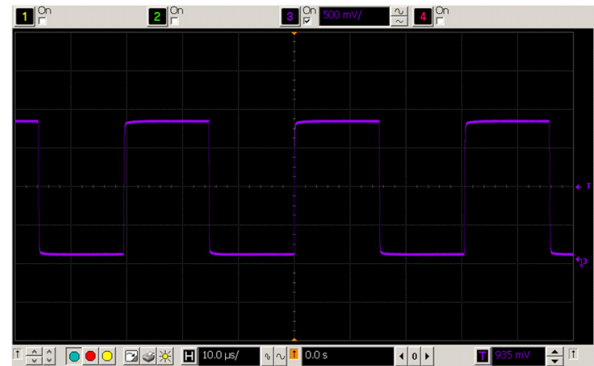

SiT1532

Smallest Footprint (1.2mm²), Ultra-Low Power 32.768 kHz
Oscillator in CSP



The Smart Timing Choice™

Dimensions and Patterns

Package Size – Dimensions (Unit: mm)	Recommended Land Pattern (Unit: mm)
<p>1.55 x 0.85 mm CSP</p> <p>1.55 ± 0.02</p> <p>0.85 ± 0.02</p> <p>#4 #3</p> <p>#1 #2</p> <p>0.315 ± 0.015</p> <p>#3 #4</p> <p>0.41 BSC</p> <p>1.00 BSC</p> <p>#2 #1</p> <p>0.04</p> <p>Polymer coating</p> <p>0.60 MAX</p> <p>0.25 (4x) NSMD pads</p> <p>0.41</p> <p>1.00</p> <p>0.35 (4x) Soldermask openings</p> <p>(soldermask openings shown with heavy dashed line)</p>	

SiT1532

Smallest Footprint (1.2mm²), Ultra-Low Power 32.768 kHz Oscillator in CSP



The Smart Timing Choice™

Ordering Information

Part number characters in blue represent the customer specific options. The other characters in the part number are fixed.

The following examples illustrate how to select the appropriate temp range and output voltage requirements:

Example 1: SiT1532AI-J4-D14-32.768

- Industrial temp & corresponding 100 ppm frequency stability. Note, 100 ppm is only available for the industrial temp range, and 75 ppm is only available for the commercial temp range.
- Output swing requirements:
 - "D" = DC-coupled receiver
 - "J" = CSP
 - "1" = V_{OH} = 1.1V

Example 2: SiT1532AC-J5-AA5-32.768

- Commercial temp & corresponding 75 ppm frequency stability. Note, 100 ppm is only available for the industrial temp range, and 75 ppm is only available for the commercial temp range.
- Output swing requirements:
 - "A" = AC-coupled receiver
 - "A" = AC-coupled receiver
 - "5" = 500mV swing
 - "4" = V_{OL} = 0.4V

SiT1532AI-J4-D14-32.768S

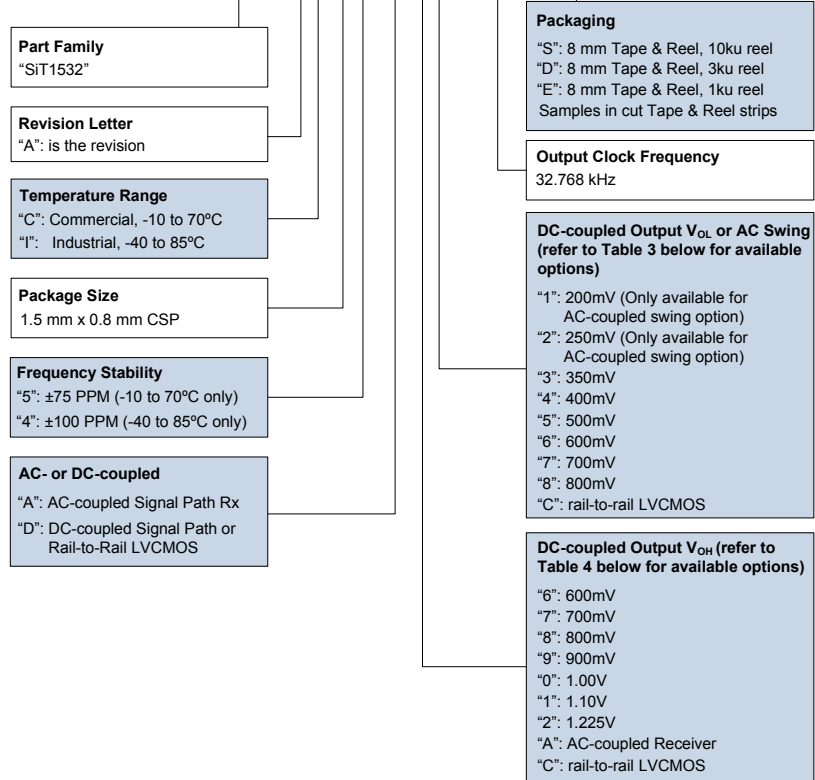

Acceptable AC-Coupled Swing Levels

Swing	0.800	0.700	0.600	0.500	0.400	0.300	0.250	0.200
Output Code	AA8	AA7	AA6	AA5	AA4	AA3	AA2	AA1

Acceptable V_{OH}/V_{OL} NanoDrive™ Levels

V _{OL} /V _{OH}	1.225	1.100	1.000	0.900	0.800	0.700	0.600
0.800	D28	D18	D08				
0.700	D27	D17	D07	D97			
0.525	D26	D16	D06	D96	D86		
0.500	D25	D15	D05	D95	D85	D75	
0.400		D14	D04	D94	D84	D74	D64
0.350		D13	D03	D93	D83	D73	D63

© SiTime Corporation 2014. The information contained herein is subject to change at any time without notice. SiTime assumes no responsibility or liability for any loss, damage or defect of a Product which is caused in whole or in part by (i) use of any circuitry other than circuitry embodied in a SiTime product, (ii) misuse or abuse including static discharge, neglect or accident, (iii) unauthorized modification or repairs which have been soldered or altered during assembly and are not capable of being tested by SiTime under its normal test conditions, or (iv) improper installation, storage, handling, warehousing or transportation, or (v) being subjected to unusual physical, thermal, or electrical stress.

Disclaimer: SiTime makes no warranty of any kind, express or implied, with regard to this material, and specifically disclaims any and all express or implied warranties, either in fact or by operation of law, statutory or otherwise, including the implied warranties of merchantability and fitness for use or a particular purpose, and any implied warranty arising from course of dealing or usage of trade, as well as any common-law duties relating to accuracy or lack of negligence, with respect to this material, any SiTime product and any product documentation. Products sold by SiTime are not suitable or intended to be used in a life support application or component, to operate nuclear facilities, or in other mission critical applications where human life may be involved or at stake. All sales are made conditioned upon compliance with the critical uses policy set forth below.

CRITICAL USE EXCLUSION POLICY
BUYER AGREES NOT TO USE SITIME'S PRODUCTS FOR ANY APPLICATION OR IN ANY COMPONENTS USED IN LIFE SUPPORT DEVICES OR TO OPERATE NUCLEAR FACILITIES OR FOR USE IN OTHER MISSION-CRITICAL APPLICATIONS OR COMPONENTS WHERE HUMAN LIFE OR PROPERTY MAY BE AT STAKE.

SiTime owns all rights, title and interest to the intellectual property related to SiTime's products, including any software, firmware, copyright, patent, or trademark. The sale of SiTime products does not convey or imply any license under patent or other rights. SiTime retains the copyright and trademark rights in all documents, catalogs and plans supplied pursuant to or ancillary to the sale of products or services by SiTime. Unless otherwise agreed to in writing by SiTime, any reproduction, modification, translation, compilation, or representation of this material shall be strictly prohibited.

SiT1532

Smallest Footprint (1.2mm²), Ultra-Low Power 32.768 kHz
Oscillator in CSP



The Smart Timing Choice™

© SiTime Corporation 2014. The information contained herein is subject to change at any time without notice. SiTime assumes no responsibility or liability for any loss, damage or defect of a Product which is caused in whole or in part by (i) use of any circuitry other than circuitry embodied in a SiTime product, (ii) misuse or abuse including static discharge, neglect or accident, (iii) unauthorized modification or repairs which have been soldered or altered during assembly and are not capable of being tested by SiTime under its normal test conditions, or (iv) improper installation, storage, handling, warehousing or transportation, or (v) being subjected to unusual physical, thermal, or electrical stress.

Disclaimer: SiTime makes no warranty of any kind, express or implied, with regard to this material, and specifically disclaims any and all express or implied warranties, either in fact or by operation of law, statutory or otherwise, including the implied warranties of merchantability and fitness for use or a particular purpose, and any implied warranty arising from course of dealing or usage of trade, as well as any common-law duties relating to accuracy or lack of negligence, with respect to this material, any SiTime product and any product documentation. Products sold by SiTime are not suitable or intended to be used in a life support application or component, to operate nuclear facilities, or in other mission critical applications where human life may be involved or at stake. All sales are made conditioned upon compliance with the critical uses policy set forth below.

CRITICAL USE EXCLUSION POLICY

BUYER AGREES NOT TO USE SITIME'S PRODUCTS FOR ANY APPLICATION OR IN ANY COMPONENTS USED IN LIFE SUPPORT DEVICES OR TO OPERATE NUCLEAR FACILITIES OR FOR USE IN OTHER MISSION-CRITICAL APPLICATIONS OR COMPONENTS WHERE HUMAN LIFE OR PROPERTY MAY BE AT STAKE.

SiTime owns all rights, title and interest to the intellectual property related to SiTime's products, including any software, firmware, copyright, patent, or trademark. The sale of SiTime products does not convey or imply any license under patent or other rights. SiTime retains the copyright and trademark rights in all documents, catalogs and plans supplied pursuant to or ancillary to the sale of products or services by SiTime. Unless otherwise agreed to in writing by SiTime, any reproduction, modification, translation, compilation, or representation of this material shall be strictly prohibited.